

## E7 APOGEE<sup>®</sup> FLN Technical Manual

*This Manual  
also available on  
[www.drives.com](http://www.drives.com)*





# Warnings and Cautions

---

This Section provides warnings and cautions pertinent to this product that if not heeded, may result in personal injury, fatality or equipment damage. Yaskawa is not responsible for consequences of ignoring these instructions.

## **WARNING**

YASKAWA manufactures component parts that can be used in a wide variety of industrial applications. The selection and application of YASKAWA products remain the responsibility of the equipment designer or end user. YASKAWA accepts no responsibility for the way its products are incorporated into the final system design. Under no circumstances should any YASKAWA product be incorporated into any product or design as the exclusive or sole safety control. Without exception, all controls should be designed to detect faults dynamically and to fail safely under all circumstances. All products designed to incorporate a component part manufactured by YASKAWA must be supplied to the end user with appropriate warnings and instructions as to that part's safe use and operation. Any warnings provided by YASKAWA must be promptly provided to the end user. YASKAWA offers an express warranty only as to the quality of its products in conforming to standards and specifications published in the YASKAWA manual. **NO OTHER WARRANTY, EXPRESS OR IMPLIED, IS OFFERED.** YASKAWA assumes no liability for any personal injury, property damage, losses, or claims arising from misapplication of its products.

## **WARNING**

Read and understand this manual before installing, operating, or servicing this drive. All warnings, cautions, and instructions must be followed. Qualified personnel must perform all activity. The drive must be installed according to this manual and local codes.

Do not connect or disconnect wiring while the power is on. Do not remove covers or touch circuit boards while the power is on. Do not remove or insert the digital operator while power is on.

Before servicing, disconnect all power to the equipment. The internal capacitor remains charged even after the power supply is turned off. Status indicator LEDs and Digital Operator display will be extinguished when the DC bus voltage is below 50 VDC. To prevent electric shock, wait at least 5 minutes after all indicators are OFF and measure DC bus voltage level to confirm that it is at a safe level.

Do not perform a withstand voltage test on any part of the unit. This equipment uses sensitive devices and may be damaged by high voltage.

The drive is not suitable for circuits capable of delivering more than the specified RMS symmetrical amperes. Install adequate branch short circuit protection per applicable codes. Refer to the specification. Failure to do so may result in equipment damage and/or personal injury.

Do not connect unapproved LC or RC interference suppression filters, capacitors, or over voltage protection devices to the output of the drive. Capacitors may generate peak currents that exceed drive specifications.

To avoid unnecessary fault displays, caused by contactors or output switches placed between drive and motor, auxiliary contacts must be properly integrated into the control logic circuit.

YASKAWA is not responsible for any modification of the product made by the user, doing so will void the warranty. This product must not be modified.

Verify that the rated voltage of the drive matches the voltage of the incoming power supply before applying power.

To meet CE directives, proper line filters and proper installation are required.

Some drawings in this manual may be shown with protective covers or shields removed, to describe details. These must be replaced before operation.

Observe Electrostatic Discharge Procedures when handling the drive and drive components to prevent ESD damage.

The attached equipment may start unexpectedly upon application of power to the drive. Clear all personnel from the drive, motor and machine area prior to applying power. Secure covers, couplings, shaft keys, machine beds and all safety equipment before energizing the drive.

# Introduction

---

This manual explains the specifications and handling of the APOGEE FLN protocol for the Yaskawa model E7 drive. The E7 drive with the APOGEE FLN protocol selected, connects the E7 drive to an APOGEE FLN network and facilitates the exchange of data.

This document pertains to the Yaskawa E7 drive. Additionally, in this document, the word “inverter”, “ac drive” and “drive” may be used interchangeably.

To ensure proper operation of this product, read and understand this manual. For details on installation and operation of the E7 drive or details on specific E7 parameters, refer to the *E7 User Manual*, document reference **TM.E7.01**. For details on E7 MODBUS communications, refer to the *E7 MODBUS® Technical Manual*, document reference **TM.E7.11**. All technical manuals and support files are available on the CD supplied with the drive and for download at [www.drives.com](http://www.drives.com).

For more information on the APOGEE FLN protocol, please visit [www.sbt.siemens.com](http://www.sbt.siemens.com).

GPD is a trademark of Yaskawa, Inc.

MODBUS® is a registered trademark of Schneider Automation, Inc.

APOGEE® FLN is a registered trademark of Siemens Building Technologies, Inc.

APOGEE Anywhere™ is a trademark of Siemens Building Technologies, Inc.

# Table of Contents

---

<b>Chapter 1 Installation.....</b>	<b>1-1</b>
Installation Check Sheet .....	1-3
APOGEE FLN Set-Up .....	1-5
<b>Chapter 2 Network Connection .....</b>	<b>2-1</b>
Physical Connection .....	2-3
<b>Chapter 3 APOGEE FLN Strategies.....</b>	<b>3-1</b>
Slope and Intercept Conversion .....	3-3
Other Functionality .....	3-5
E7 Drive Fault Numbers .....	3-6
<b>Chapter 4 APOGEE FLN Point Database .....</b>	<b>4-1</b>
APOGEE FLN Point List Summary .....	4-3
<b>Chapter 5 Cable Loss Behavior.....</b>	<b>5-1</b>
Cable Loss Configuration and Behavior .....	5-3
<b>Chapter 6 Mailbox Function.....</b>	<b>6-1</b>
Mailbox Function Points .....	6-3
<b>Chapter 7 E7 Bypass Applications.....</b>	<b>7-1</b>
Bypass/Engineered Drive Parameter Settings .....	7-3
<b>Appendix A Troubleshooting .....</b>	<b>1</b>
Troubleshooting Check List .....	3
Installing and Configuring APOGEE FLN .....	5
Wiring And Cabling .....	7
Drive Faults .....	8
<b>Appendix B Hex/Dec Conversion .....</b>	<b>1</b>
Hex/Dec Conversion Table .....	3

This page intentionally left blank.

# Chapter 1 Installation

---

*This chapter covers the initial set-up procedure for the E7 drive on an APOGEE FLN network.*

<b>Installation Check Sheet .....</b>	<b>1 – 3</b>
<b>APOGEE FLN Set-Up.....</b>	<b>1 – 5</b>

This page intentionally left blank.



# Installation Check Sheet

The following is a quick reference guide to the installation and configuration of the E7 drive with the APOGEE FLN protocol. Make a copy of this page and check-off each item as it is completed. For detailed information please refer to the detailed sections that follow.

- 1: Unpack the drive and verify that all components are present and undamaged.
- 2: Connect power to the drive and verify that the drive functions. This includes running the drive in “Hand” mode from the digital operator without the network selected or connected. Refer to the *E7 User Manual* for more information on connecting and operating the drive.
- 3: Remove power from the drive and wait for the charge lamp to be completely extinguished. Wait at least five additional minutes after all indicators are off. Measure the DC bus voltage to ensure that the drive is at a safe level and completely discharged.
- 4: Connect the drive to the APOGEE FLN communication network. Refer to **Chapter 2 – Network Connection** for the APOGEE FLN connection procedure.
- 5: If this drive is either the first or the last device on the network, set the terminating resistor switch, S1-1, to ON. If this device is not the first or last device on the network, set the terminating resistor switch, S1-1, to OFF. Refer to **Chapter 2 – Network Connection** for details.
- 6: Configure the APOGEE FLN network for the drive. Refer to the documentation included with the APOGEE FLN Application 2721 configuration software.
- 7: Set parameters b1-01, b1-02, H5-01, H5-02 and H5-08 to their appropriate values. Refer to **Table 1.1 - Drive Communication Parameter Settings** on page 1-5.

This page intentionally left blank.

# APOGEE FLN Set-Up

A Yaskawa Electric America, Inc. representative is responsible for proper configuration of the drive for its primary application, while a Siemens Building Technologies, Inc. representative is responsible for field panel programming to make use of the drive's functionality in the building automation system. As such, there must be coordination between the Yaskawa Electric America and Siemens Building Technologies representatives to ensure that the programming of the drive is consistent with the particular application requirements. After verifying that the drive installation and wiring are correct, apply power to the drive. Table 1.1 below lists the parameters and their values required for proper APOGEE FLN communication and control.

E7 Drive Parameter Settings For APOGEE FLN Communications

Table 1.1 - Drive Communication Parameter Settings		
Parameter Number	Digital Operator Display	Settings for APOGEE FLN Communication
<b>b1-01</b>	<b>Reference Source</b>	<b>2: Serial Com</b>
<b>b1-02</b>	<b>Run Source</b>	<b>2: Serial Com</b>
<b>H5-01</b>	<b>Serial Comm Adr</b>	<b>Select the drive address (default = 1Fh (31 dec))</b>
<b>H5-02</b>	<b>Serial Baud Rate</b>	<b>2: 4800 Baud</b>
<b>H5-08</b>	<b>Protocol Select</b>	<b>2: FLN(APOGEE)</b>

## CAUTION

A YEA representative should set the drive parameters to their appropriate values. Changes made to the parameters other than what is listed in the table above can result in damaging the drive or building equipment.

Programming The E7 Drive For APOGEE FLN

The procedure for programming the E7 drive for communication on an APOGEE FLN network is shown in the table below: Refer to the *E7 User Manual, TM.E7.01*, for detailed information on using the E7 Operator.



Table 1.2 - Drive Programming Procedure for APOGEE FLN		
Description	Key Operation	Digital Operator Display
<b>Apply Power to the drive</b>		-DRIVE- Rdy Frequency Ref <b>U1-01 = 0.00Hz</b> ----- U1-02 = 0.00Hz U1-03 = 0.00A
<b>Select Programming Menu</b> Press the <b>MENU</b> key until the display matches the display to the right.	 x3	-ADV- ** Main Menu ** ----- Programming
<b>Enter Programming Menu</b> Press the <b>DATA ENTER</b> key to select the Programming Menu (A1 blinking)		-ADV- Initialization ----- <b>A1-00 = 0</b> Select Language
<b>Select Sequence Parameters</b> Press the <b>UP ARROW</b> key until <b>Reference Source</b> is displayed (b1 blinking).  Note: The item selected will blink.	 x2	-ADV- Sequence ----- <b>b1-01 = 2</b> Reference Source

Table 1.2 - Drive Programming Procedure for APOGEE FLN







Description	Key Operation	Digital Operator Display
<p><b>Select Reference Command Source</b>                      Press <b>DATA ENTER</b> key to edit b1-01 (value blinking). Press the <b>UP ARROW</b> key to change the parameter value until the display matches the display shown on the right. Press the <b>DATA ENTER</b> key to accept the entry. "Entry Accepted" will be displayed if successful.</p> <p>Note: Since communications has not been established, a "CALL" alarm may be generated. Press the <b>STOP</b> key to clear the alarm. If communications has not been established within the timeout interval, the alarm will reoccur. Press the <b>STOP</b> key to clear the "CALL" alarm whenever it occurs.</p>		<p>-ADV-                      Reference Source                      -----                      b1-01 = 2 *2*                      Serial Com                      "1"</p>
<p><b>Select Run Command Source</b>                      Press the <b>UP ARROW</b> key until <b>Run Source</b> is displayed (02 blinking). Press <b>DATA ENTER</b> key to edit b1-02 (value blinking). Press the <b>UP ARROW</b> key to change the parameter value until the display matches the display shown on the right. Press the <b>DATA ENTER</b> key to accept the entry. "Entry Accepted" will be displayed if successful. If 02 is blinking, press the <b>RESET</b> key to go back to the b1 menu (b1 blinking).</p>		<p>-ADV-                      Run Source                      -----                      b1-02 = 2 *1*                      Serial Com                      "1"</p>
<p><b>Select Serial Communications Parameters</b>                      Press the <b>UP ARROW</b> key until Serial Com Setup is displayed (H5 blinking).</p>		<p>-ADV-                      Serial Com Setup                      -----                      H5-01 = 1F                      Serial Comm Adr</p>
<p><b>Select FLN(APOGEE)</b>                      Press the <b>RESET</b> key to select an H5 parameter (01 blinking). Press the <b>UP ARROW</b> key until H5-08 is displayed (08 blinking). Press the <b>DATA ENTER</b> key to edit the H5-08 parameter (value blinking). Press the <b>UP ARROW</b> key to change the parameter value until the display matches the display shown on the right. Press the <b>DATA ENTER</b> key to accept the entry. "Entry Accepted" will be displayed if successful.</p> <p>Note: FLN (APOGEE) must be selected prior to setting the node address.</p>		<p>-ADV-                      Protocol Select                      -----                      H5-08 = 2 *2*                      FLN (APOGEE)                      "0"</p>

Table 1.2 - Drive Programming Procedure for APOGEE FLN

Description	Key Operation	Digital Operator Display
<p><b>Select Node Address</b>                      Press the <b>DOWN ARROW</b> key until parameter H5-01 is displayed (01 blinking). Press the <b>DATA ENTER</b> key to edit parameter H5-01 (value blinking). Press the <b>RESET</b> or <b>RIGHT ARROW</b> key to select the digit to edit. The selected digit will blink. Press the <b>UP ARROW</b> or <b>DOWN ARROW</b> keys to change the value of the selected digit until the correct value is displayed. Press the <b>DATA ENTER</b> key to accept the entry. Edit all digits prior to pressing the <b>DATA ENTER</b> key. "Entry Accepted" will be displayed if successful.</p>		<p style="text-align: center;">-ADV- Serial Comm Adr</p> <p style="text-align: center;">-----</p> <p style="text-align: center;">H5-01 = 1F* (0~63) "1F"</p> <p>*This is always entered as a hexadecimal value. Refer to the conversion chart in Appendix B for information on converting decimal values to their hexadecimal equivalents</p>
<p><b>Select Baud Rate of 4800 Baud</b>                      Press the <b>UP ARROW</b> key until parameter H5-02 is displayed (02 blinking). Press the <b>DATA ENTER</b> key to edit parameter H5-02 (value blinking). Press the <b>UP ARROW</b> key to change the parameter value until the display matches the display shown on the right. Press the <b>DATA ENTER</b> key to accept the entry. "Entry Accepted" will be displayed if successful.</p>		<p style="text-align: center;">-ADV- Serial Baud Rate</p> <p style="text-align: center;">-----</p> <p style="text-align: center;">H5-02 = 2 *3* 4800 Baud "3"</p>
<p><b>Select The Drive Mode</b></p>		<p style="text-align: center;">-DRIVE- ** Main Menu **</p> <p style="text-align: center;">-----</p> <p style="text-align: center;">Operation</p>
<p><b>Enter The Drive Mode</b></p>		<p style="text-align: center;">-DRIVE- Frequency Ref Rdy</p> <p style="text-align: center;">U1-01 = 0.00Hz</p> <p style="text-align: center;">-----</p> <p style="text-align: center;">U1-02 = 0.00Hz U1-03 = 0.00A</p>

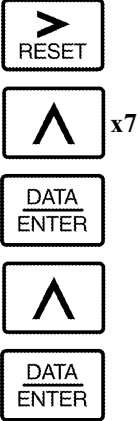
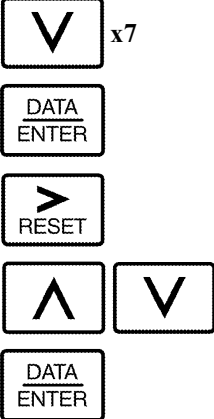
This page intentionally left blank.

# Chapter 2 Network Connection

---

*This chapter discusses how to connect the E7 drive to an APOGEE FLN network.*

**Physical Connection ..... 2 – 3**

This page intentionally left blank.



# Physical Connection

Communication on the network is half-duplex, two wire RS-485, with communication parameters fixed at 4800 baud, eight data bits, no parity and one stop bit. The network cable is a shielded two-conductor cable.

## Network Connection

Connect a jumper between R+ and S+ and R- and S-.

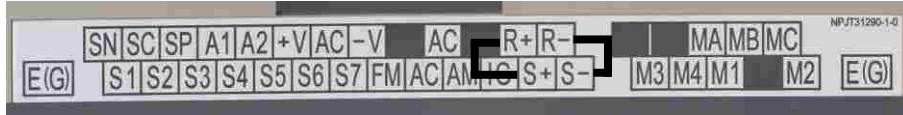

Figure 2.1 – E7 Terminal Block Jumper Connections

Connect the positive (+) cable lead to S+. Connect the negative (-) cable lead to S-.

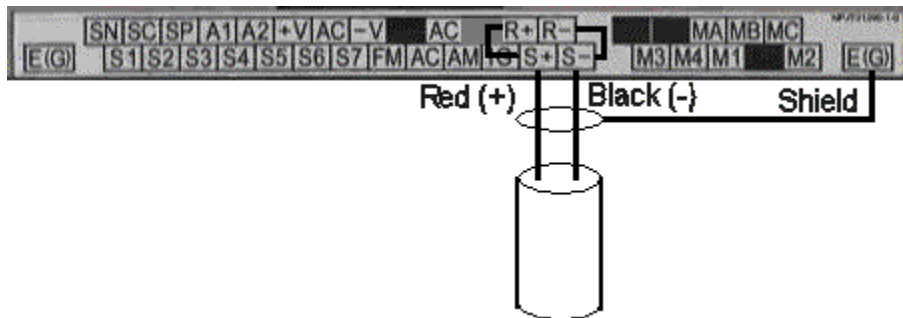

Figure 2.2 – APOGEE FLN Network Cable Connections

---

## ◆ Network Termination

Each APOGEE FLN network segment must be terminated on both ends to eliminate signal reflections. It is recommended that the Siemens Building Automation BLN Trunk Terminator (PN: 538-664) be used and that the network termination switch on the E7 drive, S1-1, be set to OFF.

This page intentionally left blank.

# Chapter 3 APOGEE FLN Strategies

---

*This chapter covers APOGEE FLN point functionality, examples of calculating new slope and intercept values and fault numbers.*

<b>Slope &amp; Intercept Conversion .....</b>	<b>3 – 3</b>
<b>Other Functionality .....</b>	<b>3 – 5</b>
<b>E7 Drive Fault Numbers .....</b>	<b>3 – 6</b>

This page intentionally left blank.

# Slope and Intercept Conversion

Several drive parameters are available for monitoring purposes. These include FREQ OUTPUT (Point 3), SPEED (Point 5), CURRENT (Point 6), TORQUE (Point 7), POWER (Point 8), DRIVE TEMP (Point 9), KWH (Point 10), and RUN TIME (Point 12). These points can be unbundled for monitoring or used in various global control strategies.

---

## ◆ Drive Controlled Feedback

The most typical application is Supervisory Control. The sensor for the control variable (e.g., water temperature) is hard-wired to the drive and the control device (fan) is modulated using the PI control loop that is built into the drive. The setpoint for the control variable (water temperature set point) is unbundled and commanded by the field panel, based on some building control strategy implemented in PPCL.

When this strategy is used, the point to unbundle and command for the set point is INPUT REF 1 (Point 60). The control variable (e.g., water temperature) can be monitored by unbundling PI FEEDBACK (Point 62). These points are provided in units of percent, where 0% and 100% correspond to the range of the sensor being used to measure the control variable. These points have default units in Hz. If other units are required, unbundle these points with appropriate slopes and intercepts. The new intercept will be equal to the lowest value of the desired range. The following formula lets you define a new slope and intercept in order to accomplish the unit conversion.

$$\text{New Slope} = \frac{(\text{Desired Range}) \times (\text{Slope of Existing Point})}{(\text{Range of Existing Point})}$$

$$\text{New Slope} = \frac{(60 - 0)\text{Hz} \times (0.01)}{(100 - 0)\%} = 0.006$$

### Conversion Example

You are controlling water temperature from a cooling tower using the drive to control a fan. The temperature sensor has a range of 30°F to 250°F. To unbundle the set point (INPUT REF 1), for commanding in degrees Fahrenheit, where 0 to 60 Hz is equal to 30°F to 250°F:

New Intercept = 30 (the temperature that corresponds to 0%)

$$\text{New Slope} = \frac{(\text{Desired Range}) \times (\text{Slope of Existing Point})}{(\text{Range of Existing Point})}$$

$$\text{New Slope} = \frac{(250 - 30)^{\circ}\text{F} \times (0.1)}{(100 - 0)\%} = 0.22$$

### Formula Notes:

Desired Range = Range Maximum – Range Minimum

Range of Existing Point = Existing Range Maximum – Existing Range Minimum

## ◆ Field Panel Controlled Feedback

In this strategy, the sensor is connected to the APOGEE FLN network at a remote location, and the control loop is executed in PPCL. The drive speed command is passed from the field panel to the drive by commanding INPUT REF 1 (Point 60).

### CAUTION

This strategy is not recommended because it means that the loop is being closed over the network. Delays due to processor scan time and network traffic can cause control to be degraded or lost. Damage to HVAC equipment may result.

#### Unbundle the FEEDBACK

To unbundle the feedback (PI FEEDBACK) for monitoring in degrees Fahrenheit:

New Intercept = 30

$$\text{New Slope} = \frac{(\text{Desired Range}) \times (\text{Slope of Existing Point})}{(\text{Range of Existing Point})}$$

$$\text{New Slope} = \frac{(250 - 30)^{\circ}\text{F} \times (0.01)}{(100 - 0)\%} = 0.022$$

#### Formula Notes:

Desired Range = Range Maximum – Range Minimum

Range of Existing Point = Existing Range Maximum – Existing Range Minimum

## ◆ Other Functionality

Each of the following functions must be enabled during start-up of the Drive:

### Enable the drive to run

RUN ENABLE (Point 35) can be commanded to require the drive to have a physical input (Terminal S3) set before the drive can run. This works in conjunction with CMD RUN.STOP (Point 24) or the CMD REV.STOP (Point 22). If RUN ENABLE (Point 35) is commanded ON then terminal S3 needs to be on and CMD RUN.STOP (Point 24) or CMD REV.STOP (point 22) needs to be commanded ON for the drive to run. If, on the other hand, RUN ENABLE (Point 35) is commanded OFF, then to run the drive CMD RUN.STOP (Point 24) or CMD REV.STOP (Point 22), is the only point that needs to be commanded ON.

### Start and stop the drive

CMD RUN.STOP (Point 24) can be commanded to run the drive in the forward direction. STOP.RUN (Point 23) shows the current status of the drive.

### Change directions

CMD REV.STOP (Point 22) can be commanded to run the drive in the reverse direction. FWD.REV (Point 21) shows the current direction of the drive rotation.



Improper drive direction may damage HVAC equipment if parameter b1-04, Reverse Enable, is improperly set (b1-04 = 0).

### Lock the E7 panel

Locking the panel prevents the user from using the HAND and OFF keys locally at the drive panel. LOCK PANEL (Point 33) can be commanded to lock and unlock the panel.

### Digital Outputs

MULTI OUT 1 (Point 40), MULTI OUT 2 (Point 41), and MULTI OUT 3 (Point 42) are physical digital outputs on the drive. Their purpose depends on how the drive has been set-up. The drive can be programmed so that these points can display various limits, warnings, and status conditions. Some examples include frequency limit, over current, and motor over temperature fault.

### Loop gain

PID P GAIN (Point 63) and PID I TIME (Point 64) are the gain and integral time parameters similar to the P and I gains in the APOGEE Terminal Equipment Controllers. The E7 drive's PI loop is structured differently than the Siemens loop, so there is not a one-to-one correspondence between the gains.

### Reading and resetting faults

OK.FAULT (Point 93) shows the current status of the Drive. FAULT CODE (Point 17) contains the code for the most current fault. LST FLT CODE (Point 66) contains the code for the previous fault. See table below for descriptions of the fault codes. The drive can be reset back to OK mode by commanding RESET FAULT (Point 94) to RESET.

# E7 Drive Fault Numbers

Table 3.1 - Description of Fault Numbers	
Fault Number	Description
1	DC Bus Fuse Open (PUF)
2	DC Bus Under Voltage (UV1)
3	Control Power Supply Under Voltage (UV2)
4	MC Answerback (UV3)
5	Short Circuit Fault
6	Ground Fault (GF)
7	Over Current (OC)
8	DC Bus Over Voltage (OV)
9	Overheat Fault (OH)
10	Overheat 1 Fault (OH1)
11	Motor Overload (OL1)
12	Inverter Overload (OL2)
13	Over Torque Detection 1 (OL3)
14	Over Torque Detection 2 (OL4)
15	N/A
16	N/A
17	External Fault 3 (EF3)
18	External Fault 4 (EF4)
19	External Fault 5 (EF5)
20	External Fault 6 (EF6)
21	External Fault 7 (EF7)
22	External Fault 8 (EF8)
23	Drive Fan Fault
24	Over Speed Fault
25	N/A
26	N/A
27	N/A
28	Output Phase Loss (LF)
29	Overheat 3 (OH3)
30	Operator Connection Fault (OPR)
31	Err Fault
32	Overheat 4 Fault (OH4)
33	Modbus Com Error (CE)
34	N/A
35	N/A
36	N/A
37	N/A
38	N/A
39	External Fault 0 (EF0)
40	PID Feedback Loss
41	N/A
42	N/A
43	N/A



# Chapter 4 APOGEE FLN Point Database

---

*This chapter shows the APOGEE FLN point database for Application 2721.*

<b>APOGEE FLN Point List Summary .....</b>	<b>4 – 3</b>
<b>APOGEE FLN Logical Analog Input (LAI) Summary .....</b>	<b>4 – 6</b>
<b>APOGEE FLN Logical Analog Output (LAO) Summary .</b>	<b>4 – 7</b>
<b>APOGEE FLN Logical Digital Input (LDI) Summary .....</b>	<b>4 – 8</b>
<b>APOGEE FLN Logical Digital Output (LDO) Summary ..</b>	<b>4 – 8</b>

This page intentionally left blank.

# APOGEE FLN Point List Summary

This database is for APOGEE FLN Application 2721 and features 97 logical points: 29 Logical Analog Inputs (LAI), 35 Logical Analog Outputs (LAO), 19 Logical Digital Inputs (LDI) and 14 Logical Digital Outputs (LDO). These points configure, control or monitor the operation of the Drive.

Information to consider when referencing this table:

1. Points not listed are not used in this application.
2. A single value in a column means that the value is the same in English units and in SI units.
3. Point numbers that appear in brackets, e.g. {03}, can be unbundled at the field panel.

Table 4 .1 - APOGEE FLN Application 2721 Point Number Summary

Point Number	Point Type	Point Name	Factory Default (SI Units)	Engr. Units (SI Units)	Slope (SI Units)	Intercept (SI Units)	On Text	Off Text	E7 Parameter
01	LAO	CTLR ADDRESS	31	-	1	0	-	-	H5-01
02	LAO	APPLICATION	-	-	1	0	-	-	-
{03}	LAI	FREQ OUTPUT	0	HZ	0.01	0	-	-	U1-02
{04}	LAI	PCT OUTPUT	0	PCT	0.01	0	-	-	-
{05}	LAI	SPEED	0	RPM	0.01	0	-	-	-
{06}	LAI	CURRENT	0	AMPS (A)	0.01	0	-	-	U1-03
{07}	LAI	TORQUE	0	PCT	0.1	0	-	-	-
{08}	LAI	POWER	0	KW	0.1	0	-	-	U1-08
{09}	LAI	DRIVE TEMP	0	DEG F / C	1	0	-	-	U1-41
{10}	LAI	DRIVE KWH	0	KWH	0.1	0	-	-	U1-29
{11}	LAI	MWH	0	MWH	1	0	-	-	U1-30
{12}	LAI	RUN TIME	0	HRS	1	0	-	-	U1-13
{13}	LAI	DC BUS VOLT	0	PCT	1	0	-	-	U1-07
{14}	LAI	AC OUT VOLT	0	VOLTS (V)	0.1	0	-	-	U1-06
15	LAI	PAR N9.01	0	AMPS (A)	0.01	0	-	-	N9-01
{16}	LAI	RUN TIMEX10K	0	10K HR	1	0	-	-	U1-13
{17}	LAI	FAULT CODE	0	-	1	0	-	-	U2-01
{18}	LDI	MINOR FLT	NO FLT	-	1	0	FAULT	NO FLT	U1-12 (Bit 6)
{19}	LDI	MAJOR FLT	NO FLT	-	1	0	FAULT	NO FLT	U1-12 (Bit 7)
20	LAO	OVRD TIME	1	HRS	1	0	-	-	-
{21}	LDI	FWD.REV	FWD	-	1	0	REV	FWD	U1-12 (Bit 2)
{22}	LDO	CMD REV.STOP	STOP	-	1	0	REV	STOP	-
{23}	LDI	RUN.STOP	STOP	-	1	0	RUN	STOP	U1-12 (Bit 0)
{24}	LDO	CMD RUN.STOP	STOP	-	1	0	FWD	STOP	-
{25}	LDI	ZERO SPEED	OFF	-	1	0	ON	OFF	U1-12 (Bit 1)
{26}	LDI	SPEED AGREE	NO AGR	-	1	0	AGREE	NO AGR	U1-12 (Bit 4)
{27}	LDI	DRIVE READY	NOTRDY	-	1	0	READY	NOTRDY	U1-12 (Bit 5)
{28}	LDI	LOC.REM MON	REMOTE	-	1	0	LOCAL	REMOTE	-
{29}	LDO	DAY.NGT	DAY	-	1	0	NGT	DAY	-
30	LAO	CURRENT LIM	0	AMPS (A)	0.01	0	-	-	E2-01
31	LAO	ACCEL TIME 1	0	SEC	0.1	0	-	-	C1-01
32	LAO	DECEL TIME 1	0	SEC	0.1	0	-	-	C1-02
33	LDO	LOCK PANEL	UNLOCK	-	1	0	LOCK	UNLOCK	-
35	LDO	RUN ENABLE	STOP	-	1	0	ENABLE	STOP	-
36	LAO	STALL PRE RN	90	PCT	30	0	-	-	L3-06
37	LAO	STALL PRE AC	120	PCT	1	0	-	-	L3-02
38	LAO	FREQ UP LIM	100	PCT	0.1	0	-	-	D2-01
39	LAO	FREQ LOW LIM	0	PCT	0.1	0	-	-	D2-02
{40}	LDI	MULTI OUT 1	OFF	-	1	0	ON	OFF	U1-11 (Bit 0)
{41}	LDI	MULTI OUT 2	OFF	-	1	0	ON	OFF	U1-11 (Bit 1)

Table 4 .1 - APOGEE FLN Application 2721 Point Number Summary

Point Number	Point Type	Point Name	Factory Default (SI Units)	Engr. Units (SI Units)	Slope (SI Units)	Intercept (SI Units)	On Text	Off Text	E7 Parameter
{42}	LDI	MULTI OUT 3	OFF	-	1	0	ON	OFF	U1-11 (Bit 2)
{43}	LDI	SAFETY ILOCK	OFF	-	1	0	ON	OFF	-
{44}	LDO	MF INP 1	OFF	-	1	0	ON	OFF	-
{45}	LDO	MF INP 2	OFF	-	1	0	ON	OFF	-
{46}	LDO	MF INP 3	OFF	-	1	0	ON	OFF	-
{47}	LDO	MF INP 4	OFF	-	1	0	ON	OFF	-
{48}	LDO	MF INP 5	OFF	-	1	0	ON	OFF	-
49	LAO	JUMP FREQ 1	0	HZ	0.1	0	-	-	D3-01
50	LAO	JUMP FREQ 2	0	HZ	0.1	0	-	-	D3-02
51	LAO	JUMP FREQ 3	0	HZ	0.1	0	-	-	D3-03
52	LAO	JUMP FREQ BW	0	HZ	0.1	0	-	-	D3-04
53	LAO	NUM AUTOSTRT	0	-	1	0	-	-	L5-01
54	LAO	POWER LOSS RT	0.1	SEC	0.1	0	-	-	L2-02
55	LAO	RUN OP MODE	1	-	1	0	-	-	b1-02
56	LAO	REF OP MODE	1	-	1	0	-	-	b1-01
57	LAO	OPER DISP MD	0	-	1	0	-	-	o1-03
{58}	LDI	MF IN 1 MON	OFF	-	1	0	ON	OFF	U1-10 (Bit 2)
{59}	LDI	MF IN 2 MON	OFF	-	1	0	ON	OFF	U1-10 (Bit 3)
{60}	LAO	INPUT REF 1	0	HZ	0.01	0	-	-	-
61	LAO	INPUT REF 2	0	HZ	0.01	0	-	-	D1-02
{62}	LAI	PID FEEDBACK	0	PCT	0.01	0	-	-	U1-24
63	LAO	PID P GAIN	1	-	0.01	0	-	-	b5-02
64	LAO	PID I TIM	1	SEC	0.1	0	-	-	b5-03
65	LDO	PID MODE SEL	DISABLE	-	1	0	ENABLE	DISABLE	b5-01
{66}	LAI	LST FLT CODE	0	-	1	0	-	-	U2-02
{67}	LAI	FREF.FLT	0	HZ	0.01	0	-	-	U2-03
{68}	LAI	OUT FREQ.FLT	0	HZ	0.01	0	-	-	U2-04
{69}	LAI	OUT CUR.FLT	0	AMPS (A)	0.01	0	-	-	U2-05
70	LAO	RD PARAM NUM	1	-	1	0	-	-	-
71	LAI	RD PARAM DAT	0	-	1	0	-	-	-
72	LAO	WR PARAM NUM	1	-	1	0	-	-	-
73	LAO	WR PARAM DAT	0	-	1	0	-	-	-
{74}	LDI	MF IN 3 MON	OFF	-	1	0	ON	OFF	U1-10 (Bit 4)
{75}	LAI	OUT VOLT.FLT	0	VOLTS (V)	0.1	0	-	-	U2-07
{76}	LAI	DC BUS.FLT	0	VOLTS (V)	1	0	-	-	U2-08
{77}	LAI	OUT PWR.FLT	0	KW	0.1	0	-	-	U2-09
{78}	LDI	MF IN 4 MON	OFF	-	1	0	ON	OFF	U1-10 (Bit 5)
{79}	LAI	PID DEVIATE	0	PCT	0.01	0	-	-	U1-36
80	LAO	PID I LIMIT	100	PCT	0.1	0	-	-	b5-04
81	LAO	PID UP LIMIT	100	PCT	0.1	0	-	-	b5-06
82	LAO	PID OFFS ADJ	100	PCT	0.1	-100	-	-	b5-07
83	LAO	PID PRI DYTM	0	SEC	0.1	0	-	-	b5-08
84	LAO	PID FB RMDS	0	-	1	0	-	-	b5-12
85	LAO	PID FB RMDL	0	PCT	1	0	-	-	b5-13
86	LAO	PID FB RMDT	1	SEC	0.1	0	-	-	b5-14
{87}	LAI	PID OUT CAP	0	PCT	0.01	0	-	-	U1-37
{88}	LAI	PID REF	0	PCT	0.01	0	-	-	U1-38
{89}	LAI	COMM ERR CD	0	-	1	0	-	-	U1-39
90	LDO	COMM FLT ENA	DISABLE	-	1	0	ENABLE	DISABLE	H5-05
91	LAO	CBL LOSS FRQ	0	HZ	0.01	0	-	-	D1-04

Table 4 .1 - APOGEE FLN Application 2721 Point Number Summary

Point Number	Point Type	Point Name	Factory Default (SI Units)	Engr. Units (SI Units)	Slope (SI Units)	Intercept (SI Units)	On Text	Off Text	E7 Parameter
92	LAO	CBL LOSS TMR	2	SEC	0.1	0	-	-	H5-09
{93}	LDI	OK.FAULT	OK	-	1	0	FAULT	OK	U1-12 (Bit 7)
{94}	LDO	RESET FAULT	NO	-	1	0	RESET	NO	-
{95}	LDI	DRV COMM ERR	NO FLT	-	1	0	FAULT	NO FLT	-
{96}	LDO	EXTERNAL FLT	OK	-	1	0	FAULT	OK	-
{97}	LDI	MF IN 5 MON	OFF	-	1	0	ON	OFF	U1-10 (Bit 6)
{99}	LAI	ERROR STATUS	0	-	1	0	-	-	-

# APOGEE FLN Logical Analog Input (LAI) Summary

Table 4.2 - APOGEE FLN Application 2721 Logical Analog Input (LAI) Summary (E7 to APOGEE FLN)								
Point Number	Database Descriptor	Units	Slope	Intercept	Default	Min	Max	E7 Parameter
3	FREQ OUTPUT	HZ	0.01	0	0	Fmin	Fmax	U1-02
4	PCT OUTPUT	PCT	0.01	0	0	0	100	-
5	SPEED	RPM	1	0	0	Fmin	Fmax	-
6	CURRENT	AMPS	0.01 or 0.1	0	0	0	DriveMax	U1-03
7	TORQUE	PCT	0.1	0	0	0	300	-
8	POWER	KW	0.1	0	0	0	100	U1-08
9	DRIVE TEMP	DEG F	1	0	DrvTemp	0	4000	U1-41
10	DRIVE KWH	KWH	0.1 or 1 kVA Dep	0	0	0	32767	U1-29
11	DRIVE MWH	MWH	1	0	0	0	32767	U1-30
12	RUN TIME	HR	1	0	0	0	32767	U1-13
13	DC BUS VOLT	VOLTS	1	0	kVA Dep	0	4000	U1-07
14	AC OUT VOLT	VOLTS	1	0	0	0	kVA Dep	U1-06
15	DRV RATED AMP	AMPS	0.01 or 0.1	0	0	0	kVA Dep	N9-01
16	RUN TIME x 10K	10K HR	1	0	0	0	32767	U1-13
17	FAULT CODE	ERR CD	1	0	0	0	-	U2-01
62	PID FEEDBACK	HZ	0.01	0	0	0	40	U1-24
66	LST FLT CODE	-	1	0	0	-	-	U2-02
67	FREF.FLT	HZ	0.01	0	0	0	400	U2-03
68	OUT FREQ.FAULT	HZ	0.01	0	0	0	400	U2-04
69	OUT CUR.FLT	AMPS	0.1	0	0	0	kVA Dep	U2-05
71	RD PARAM DAT	-	1	0	-	-	-	-
75	OUT VOLT.FLT	VOLTS	0.1	0	0	0	400	U2-07
76	DC BUS.FLT	VOLTS	1	0	0	0	4000	U2-08
77	OUT PWR.FLT	KW	0.1	0	0	0	400	U2-09
79	PID DEVIATE	PCT	0.01	0	0	0	400	U1-36
87	PID OUT CAP	PCT	0.01	0	0	0	40	U1-37
88	PID REF	PCT	0.01	0	0	0	40	U1-38
89	COMM ERR CD	-	1	0	0	0	4000	U1-39
99	ERROR STATUS	-	1	0	0	0	255	-

# APOGEE FLN Logical Analog Output (LAO) Summary

Table 4.3 - APOGEE FLN Application 2721 Logical Analog Output (LAO) Summary (APOGEE FLN to E7)								
Point Number	Database Descriptor	Units	Slope	Intercept	Default	Min	Max	E7 Parameter
1	CTRL ADDRESS	–	1	0	31	0	99	H5-01
2	APPLICATION	–	1	0	2721	0	32767	–
20	OVRD TIME	HR	1	0	8	1	255	–
30	CURRENT LIMIT	A	0.01 or 0.1	0	kVA Dep	0	1500	E2-01
31	ACCEL TIME	SEC	0.1	0	10	0	32767	C1-01
32	DECEL TIME	SEC	0.1	0	10	0	32767	C1-02
36	STALL PRE RN	PCT	30	0	90	0	170	L3-06
37	STALL PRE AC	PCT	1	0	120	0	200	L3-02
38	FREQ UP LIM	PCT	0.1	0	100	0	110	D2-01
39	FREQ LOW LIM	PCT	0.1	0	0	0	110	D2-02
49	JUMP FREQ 1	HZ	0.1	0	0	0	400	D3-01
50	JUMP FREQ 2	HZ	0.1	0	0	0	400	D3-02
51	JUMP FREQ 3	HZ	0.1	0	0	0	400	D3-03
52	JUMP FREQ BW	HZ	0.1	0	1	0	20	D3-04
53	NUM AUTOSTRT	–	1	0	0	0	10	L5-01
54	PWR LOSS RT	SEC	0.1	0	0	0	25.5	L2-02
55	RUN OP MODE	–	1	0	1	0	3	b1-02
56	REF OP MODE	–	1	0	1	0	3	b1-01
57	OPER DISP MD	–	1	0	0	0	32767	o1-03
60	INPUT REF 1	HZ	0.01	0	0	0	400	–
61	INPUT REF 2	HZ	0.01	0	0	0	400	D1-02
63	PID P GAIN	–	0.01	0	1	0	25	b5-02
64	PID I TIME	SEC	0.1	0	1	0	360	b5-03
70	RD PARAM NUM	–	1	0	–	–	–	–
72	WR PARAM NUM	–	1	0	–	–	–	–
73	WR PARAM DAT	–	1	0	–	–	–	–
80	PID I LIMIT	PCT	0.1	0	100	0	100	b5-04
81	PID UP LIM	PCT	0.1	0	100	0	100	b5-06
82	PID OFFS ADJ	PCT	0.1	-100	0	0	200	b5-07
83	PID PRI DYT M	SEC	0.01	0	0	0	10	b5-08
84	PID FB RMDS	–	1	0	0	0	2	b5-12
85	PID FB RMDL	–	1	0	1	0	2	b5-13
86	PID FB RMDT	SEC	0.1	0	1	0	25.5	b5-14
91	CBL LOSS FRQ	HZ	0.01	0	0	0	400	D1-04
92	CBL LOSS TMR	SEC	0.1	0	2	0	3600	H5-09

# APOGEE FLN Logical Digital Input (LDI) Summary

Table 4.4 - APOGEE FLN Application 2721 Logical Digital Input (LDI) Summary (E7 to APOGEE FLN)									
Point Number	Database Descriptor	Slope	Intercept	Default	Min	Max	Off (0) State	On (1) State	E7 Parameter
18	MINOR FLT	1	0	0	0	1	NO FLT	FAULT	U1-12 (Bit 6)
19	MAJOR FLT	1	0	0	0	1	NO FLT	FAULT	U1-12 (Bit 7)
21	FWD.REV	1	0	0	0	1	FWD	REV	U1-12 (Bit 2)
23	RUN.STOP	1	0	0	0	1	STOP	RUN	U1-12 (Bit 0)
25	ZERO SPEED	1	0	0	0	1	OFF	ON	U1-12 (Bit 1)
26	SPEED AGREE	1	0	0	0	1	NO AGR	AGREE	U1-12 (Bit 4)
27	DRIVE READY	1	0	0	0	1	NOTRDY	READY	U1-12 (Bit 5)
28	HND/AUTO MON	1	0	0	0	1	REMOTE	LOCAL	-
40	MULTI OUT 1	1	0	0	0	1	OFF	ON	U1-11 (Bit 0)
41	MULTI OUT 2	1	0	0	0	1	OFF	ON	U1-11 (Bit 1)
42	MULTI OUT 3	1	0	0	0	1	OFF	ON	U1-11 (Bit 2)
43	SAFETY ILOCK	1	0	0	0	1	OFF	ON	-
58	MF IN 1 MON	1	0	0	0	1	OFF	ON	U1-10 (Bit 2)
59	MF IN 2 MON	1	0	0	0	1	OFF	ON	U1-10 (Bit 3)
74	MF IN 3 MON	1	0	0	0	1	OFF	ON	U1-10 (Bit 4)
78	MF IN 4 MON	1	0	0	0	1	OFF	ON	U1-10 (Bit 5)
93	OK.FAULT	1	0	0	0	1	NO FLT	FAULT	U1-12 (Bit 7)
95	DRV COMM ERR	1	0	0	0	1	NO FLT	FAULT	-
97	MF IN 5 MON	1	0	0	0	1	OFF	ON	U1-10 (Bit 6)

# APOGEE FLN Logical Digital Output (LDO) Summary

Table 4.5 - APOGEE FLN Application 2721 Logical Digital Output (LDO) Summary (APOGEE FLN to E7)									
Point Number	Database Descriptor	Slope	Intercept	Default	Min	Max	Off (0) State	On (1) State	E7 Parameter
22	CMD REV.STOP	1	0	0	0	1	STOP	REV	-
24	CMD RUN.STOP	1	0	0	0	1	STOP	FWD	-
29	DAY.NGT	1	0	0	0	1	DAY	NGT	-
33	LOCK PANEL	1	0	0	0	1	UNLOCK	LOCK	-
35	RUN ENABLE	1	0	0	0	1	STOP	ENABLE	-
44	MF INP 1	1	0	0	0	1	OFF	ON	-
45	MF INP 2	1	0	0	0	1	OFF	ON	-
46	MF INP 3	1	0	0	0	1	OFF	ON	-
47	MF INP 4	1	0	0	0	1	OFF	ON	-
48	MF INP 5	1	0	0	0	1	OFF	ON	-
65	PID MODE SL	1	0	0	0	1	OFF	ON	b5-01
90	COMM FLT ENA	1	0	1	0	1	DISABLE	ENABLE	H5-05
94	RESET FAULT	1	0	0	0	1	RESET	OK	-
96	EXTERNAL FLT	1	0	0	0	1	FAULT	OK	-



# Chapter 5 Cable Loss Behavior

---

*This chapter describes the configurable cable loss feature of the E7 drive.*

**Cable Loss Configuration and Behavior ..... 5 – 3**

This page intentionally left blank.

# Cable Loss Configuration and Behavior

This section describes the configurable cable loss feature of the drive. This feature offers a user maximum flexibility in determining the drive's response to a loss of communication.

## Drive Behavior At Loss of Communication

After some interval without receipt of a message, the drive can be configured to respond in one of the following manners:

- Continue at last speed**
- Continue at last speed with Alarm**
- Continue at preset speed**
- Ramp to Stop with EF0 fault**
- Coast to Stop with EF0 fault**
- Emergency Stop with EF0 fault**

## APOGEE FLN Points

Three APOGEE FLN points are used to select the desired behavior:

- POINT 92 – CBL LOSS TMR**
- POINT 91 – CBL LOSS FRQ**
- POINT 90 – COMM FLT ENA**

Table 5.1 - Cable Loss Behavior Summary

Behavior	H5-04	CBL LOSS TMR (Point 92)	CBL LOSS FRQ (Point 91)	COMM FLT ENA (Point 90)
Decelerate to stop (stop time in C1-02) <b>EF0 Fault</b>	0	Timeout Interval	X	On
Coast to stop <b>EF0 Fault</b>	1	Timeout Interval	X	On
Emergency stop (stop time in C1-09) <b>EF0 Fault</b>	2	Timeout Interval	X	On
Continue at last speed	3	0	X	X
Continue at last speed with Alarm	3	Timeout Interval	X	On
Continue at preset speed with Alarm	4	Timeout Interval	Preset Speed	On

Notes:

1. Communication must first be established and then lost for these features to function as described. If a drive is powered-up without a cable connected or with the master controller offline, a communications timeout does not occur.
2. For modes which describe the drive running after a communications timeout, a run command must have been issued (RUN ENABLE (Point 35) = 'On' and either CMD RUN.FWD (Point 22) = 'On' or CMD RUN.REV (Point 24) = 'On') prior to loss of communications. For safety purposes, the drive will not automatically restart from a stopped condition. If a user requires the drive to restart automatically, additional external wiring is required to accomplish this (consult factory).

Upon expiration of the communications timeout interval, the FAULT LED lights and remains lit until communication is restored.

### Continue at Last Speed

In this mode, CBL LOSS TMR (POINT 92) is set to **0**, disabling the cable loss feature. The other two settings CBL LOSS FRQ (POINT 91) and COMM FLT ENA (POINT 90) are ignored. If communication is lost, the drive simply maintains its last commanded state. The drive will not display an alarm or fault to indicate it has lost communication. This behavior can also be achieved by setting parameter H5-04 to "3". The drive will display an alarm and continue running. For this specific condition, the COMM FLT ENA (POINT 90) must be enabled and CBL LOSS TMR (POINT 91) should be set to something other than 0.

### Continue at Preset Speed

In this mode, CBL LOSS TMR (POINT 92) is set to the desired interval, CBL LOSS FRQ (POINT 91) is set to the desired preset speed and H5-04 is set to "4". If the time between messages exceeds the timeout interval, the drive's speed command, INPUT REF 1, (Point 60) is set to the CBL LOSS FRQ (POINT 91) and the drive continues running at this new speed. COMM FLT ENA (POINT 90) must be set to 'On'.

## Stop

COMM FLT ENA (POINT 90) must be set to 'On'. In this mode, CBL LOSS TMR (POINT 92) is set to the desired interval and parameter H5-04 is set to a value of 0,1 or 2. If the time between messages exceeds the timeout interval, the drive's speed command, INPUT REF 1, (Point 60) is set to **0**. The stopping method is determined by the setting of H5-04. An **EF0** drive fault will be set.

**H5-04 = 0 selects Ramp to Stop. The deceleration time or the slope of the ramp is determined by the setting of drive parameter C1-02.**

**H5-04 = 1 selects Coast to Stop. The drive does not attempt to control the rate of deceleration.**

**H5-04 = 2 selects Emergency or Fast Stop. The deceleration time is determined by the setting of drive parameter C1-09.**

## CAUTION

The behavior of the drive at cable loss is controlled by parameter H5-04. This drive parameter works with the points as described in the table above to determine how the drive will respond to a cable loss. If the cable loss fault is disabled, the drive will continue in its last state, if running the drive will continue to run at the last commanded frequency.

## Fault (EF0)

In this mode, CBL LOSS TMR (POINT 92) is set to the desired interval, COMM FLT ENA (POINT 90) or is set to '**On**' and either CMD RUN.FWD (Point 22) or CMD RUN.REV (Point 24) is set to '**On**'. If the time between messages exceeds the timeout interval, an '**EF0**' fault is declared and the drive stops. The stopping method is controlled by the setting of H5-04 and is described above. CBL LOSS FRQ (POINT 91) is ignored.

# Chapter 6 Mailbox Function

---

*This chapter defines the APOGEE FLN points that read and write E7 drive parameters.*

**Mailbox Function Points ..... 6 – 3**

This page intentionally left blank.

# Mailbox Function Points

## ◆ Reading a Drive Parameter

Two points are defined for reading any drive parameter:

#70 Specifies the parameter to be read from

#71 Reports the value of the parameter specified in Point #70

When this point is read, it retrieves data from the parameter and sends it to the controller

Example:

Entering a value of 387 (183 hex) in Point #70 specifies drive parameter b1-04. Reading Point #71 returns the current setting of parameter b1-04 to the controller

## Writing to a Drive Parameter

Two points are defined for writing to any drive parameter:

#72 Specifies the parameter to be written to

#73 Entry location of the value to be written to the parameter specified in Point #72

When this point is written to, it will write the value to the drive. An enter or accept command does not need to be sent for the data to be taken by the drive. The behavior of the write is the same as with the digital operator. If the drive is running, there are a limited number of drive parameters that can be written to.

Example:

Entering a value of 387 (183 hex) in Point #72 specifies drive parameter b1-04. Commanding Point #73 to a value of 1 enables the drive for reverse run.

Refer to either the *E7 User's Manual* or the *E7 Programming Manual* for MODBUS® communication set-up and configuration. The *E7 User's Manual* and the *E7 Programming Manual* provide references to E7 drive parameters and their respective drive addresses and functions.

This page intentionally left blank.



# Chapter 7 E7 Bypass Applications

---

*This chapter lists the typical parameters for a bypass/engineered drive.*

**Bypass/Engineered Drive Parameter Settings..... 7 – 3**

This page intentionally left blank.

# Bypass/Engineered Drive Parameter Settings

For many applications, the drive is integrated into a *bypass* or *engineered* package. This type of package typically features an enclosure with contactors that allow the user to run the motor from line power (bypass mode) or from the drive (drive mode). This package also provides the flexibility for interfacing normally closed safety interlocks (fire status, freeze status, vibration sensors, etc.) which stop the drive if the contacts open.

## Typical Parameter Settings

A bypass/engineered drive is supplied with a list of parameters and their default values. Use the table below to record any parameter modifications for this particular application.

Table 7.1 - Typical Bypass/Engineered Drive Parameters

Parameter Number	Bypass Settings		Description
	Default	User	
E1-01			Input Voltage (VAC) – Parameter defaults dependent on drive model
E1-05			Maximum Output voltage (VAC) – Parameter defaults dependent on drive model
E2-01			Motor Rated Current (FLA) (A) – Parameter defaults dependent on drive model
T1-02			Motor Rated Power (kW) – Parameter defaults dependent on motor
T1-04			Motor Rated Current (FLA) (A) – Parameter defaults dependent on motor
A1-01	2		Parameter Access Level (2 – Advanced)
b1-01			Frequency Reference Source (dependent on options specified)
b1-02			Command Source (dependent on options specified)
b1-03	0		Stopping Method (0 – Ramp to Stop) (ramp slope set by C1-02)
b1-04	1		Reverse Operation (1 – Disabled)
b1-07	1		Local/Remote RUN Selection (1 – Accept External RUN)
b1-08	1		RUN Command During Programming (1 – Enabled)
b1-12			HAND Mode Frequency Reference Selection (Operator Keypad)
b2-02	50%		DC Injection Braking Current (50%)
b2-03	5.0 sec		DC Injection Braking Current @ Start (5.0sec)
b2-09	0.0A		Motor Preheat Current
b3-01	1		Speed Search Select (1 – Enabled (Speed Estimated))
b8-01	1		Energy Conservation Control Select (1 – Enabled)
C1-01	60.0 sec		Acceleration Time
C1-02	60.0 sec		Deceleration Time
d1-01	10.0 Hz		Frequency Reference 1 (HAND Mode) (see H1-03)
d1-02	20.0 Hz		Frequency Reference 2 (HAND Mode) (see H1-03)
E1-01			Input Voltage– Parameter defaults dependent on drive model
E1-03	7		V/F Pattern Select
E1-05			Output Voltage– Parameter defaults dependent on drive model
F6-01	3		Operation After Communication Loss (3 – Alarm Only)
H1-01	6A		Terminal S3 Function (Drive Enable)
H1-02	6		Terminal S4 Function (Local /Remote Select)
H1-03	6C		Terminal S5 Function (Frequency Reference 2 (N.O.))
H1-04	20		Terminal S6 Function (External Fault (N.O.))
H1-05	8		Terminal S7 Function (External Base Block (N.O.))
H2-02	3B		Terminal M3-M4 (Command Source – Serial)

Table 7.1 - Typical Bypass/Engineered Drive Parameters

Parameter Number	Bypass Settings		Description
	Default	User	
H3-08	2		Terminal A2 (0–10vdc)
H3-09	2		Terminal A2 (Auxiliary Frequency Reference)
H3-12	0.3 sec		Analog Input Filter Time
H3-13	0		Master Frequency Reference Terminal Select (0 – Terminal A1)
L2-01	2		Momentary Power Loss Detection Select (2 – CPU power active (UV fault not detected))
L4-05	1		Frequency Reference Loss Detection Select (1 – RUN @ 80% of frequency prior to loss)
L5-01	10		Number of Re-Start Attempts
L5-03	600.0 sec		Maximum Restart Time After Fault
L6-01	6		Torque Detection Select (6 – No Load Detect and Alarm)
L6-02	15%		Torque Detection Level (% of drive rated current)
L6-03	10.0 sec		Torque Detection Time
L8-03	4		Overheat Pre-Alarm Operation Select (4 – Alarm and Reduce)
L8-11	300 sec		Heatsink cooling Fan Operation Delay Time
L8-19	20%		Overheat Frequency Reference Reduction Level
o2-01	0		Local/Remote Key Function (0 - Disabled)
o2-02	0		OFF Key Function (0 – Disabled)
o2-05	1		Frequency Reference Setting Method select (1 – Enabled (Enter key Not Required from Keypad)
o2-08	1		Cumulative Operation Time Select (1 – Time @ RUN)
o3-02	1		Keypad COPY Function Select (1 – Enabled)

# Appendix A Troubleshooting

---

*This appendix describes the steps necessary to troubleshoot the E7 drive communicating on an APOGEE FLN network.*

<b>Troubleshooting Check List .....</b>	<b>A - 3</b>
<b>Installing and Configuring APOGEE FLN .....</b>	<b>A - 5</b>
<b>Wiring And Cabling .....</b>	<b>A - 7</b>
<b>Drive Faults .....</b>	<b>A - 8</b>

This page intentionally left blank.

# Troubleshooting Check List

- 1: Connect power to the drive and verify that the drive operates correctly in HAND mode from the digital operator without being connected to the network. Record the drive model number and "spec" number at this time:

Model Number: CIMR-E7U \_\_\_ \_\_\_ \_\_\_ \_\_\_ (e.g. CIMR-E7U20P4)

"SPEC" Number: \_\_\_ \_\_\_ \_\_\_ \_\_\_ \_\_\_ \_\_\_ (e.g. 20P41A)

- 2: Record the control board part number:

ETC - \_\_\_ \_\_\_ \_\_\_ \_\_\_ \_\_\_ \_\_\_ - \_\_\_ \_\_\_ \_\_\_ \_\_\_ \_\_\_ \_\_\_ (e.g. ETC-618021-S2012)

- 3: All network devices have unique addresses and drives are addressed between 0-99 (0-63 hex).

Drive address: \_\_\_\_\_

- 4: The Run/Stop command source parameter, b1-02 is set correctly.

b1-02: \_\_\_\_\_

- 5: The Speed Command source parameter, b1-01, is set correctly.

b1-01: \_\_\_\_\_

- 6: The correct cable type is used: Mfg: \_\_\_\_\_ P/N: \_\_\_\_\_

- 7: All cable connections are correct per device schematic and are secure.

- 8: All cables have been checked for continuity. There are no breaks or shorts.

- 9: The network is correctly terminated.

- 10: The shield is continuous throughout the network and is properly grounded on each end.

- 11: The network cable is routed away from any high voltage cable(s) or source(s).

- 12: All network devices have been tested for conformance with the APOGEE FLN specification.

This page intentionally left blank.



# Installing and Configuring APOGEE FLN

The following is a short guide to troubleshooting the APOGEE FLN installation and configuration. It highlights some of the most common issues faced when diagnosing and correcting issues associated with the startup and operation of an E7 drive with APOGEE FLN building automation network. While most of the information is centered on the application of the drive, the guidelines presented are applicable in most APOGEE FLN networks.

Diagnosis of network fault issues will typically fall into three categories: 1: Installation/set-up of APOGEE FLN, 2: wiring and cabling issues, and 3: network configuration/diagnostics. Each of these areas will be discussed after to help resolve common problems associated in APOGEE FLN network troubleshooting.

## Drive Operates Correctly Without Network Enabled

Before programming the drive for APOGEE FLN communication, **verify that the drive functions properly**. Refer to the *E7 User Manual* for information on the drive's installation and operation.

## Network Cable Is Connected Correctly And Securely

Connect a jumper between R+ and S+ as well as R- and S-. Connect network cable to terminals S+ and S-.

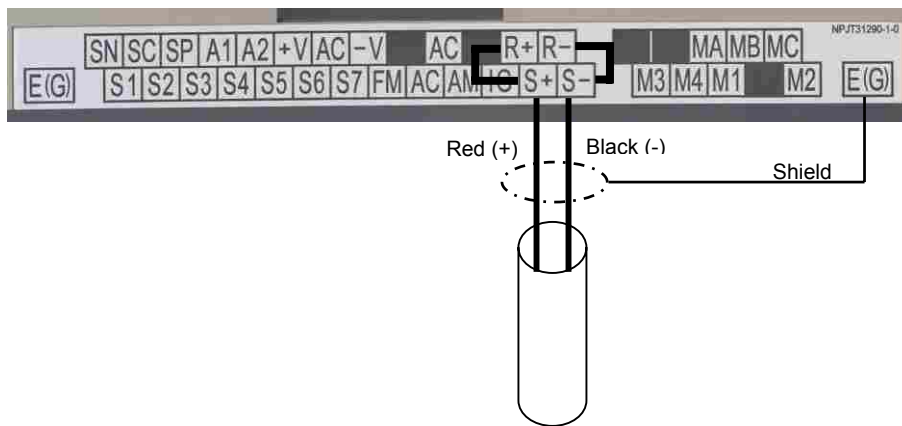

Figure A.1 – E7 APOGEE FLN Network Connections

## Run/Stop Operation Parameter Is Set Correctly

The run/stop operation parameter needs to be set for “Serial Com”.

Parameter Number	Setting Choices	Setting Descriptions
b1-02	0	Operator
	1	Terminals
	2	<b>Serial Com FLN (APOGEE)</b>
	3	Option PCB

## ◆ Speed Command Operation Parameter Is Set Correctly

The speed command operation parameter needs to be set for “Serial Com”.

Table A.2 - Speed Command Operation Parameter		
Parameter Number	Setting Choices	Setting Descriptions
b1-01	0	Operator
	1	Terminals
	<b>2</b>	<b>Serial Com (APOGEE FLN)</b>
	3	Option PCB

Correct and Unique Network Address

Each device on an APOGEE FLN network requires its own unique address. The drive also needs to be programmed to accept the APOGEE FLN protocol.

Table A.3 - Serial Communication Device Address Parameter		
Parameter Number	Setting Range	Setting Description
H5-01	0 to 63 hex	Serial communication device address
H5-08	0 to 2	<b>2: FLN (APOGEE)</b>

# Wiring And Cabling

## ◆ The network cable is the correct type

Specification	Description
Cable Configuration	Twisted Shielded Pair
Gauge	18-20 AWG (Solid or Stranded)
Wire Lay	Minimum 6 twists per foot
Shields	100% foil with drain wire
NEC Type	UL Type CMP
Temperature	60°C or higher

### Cable Lengths Are Within Specified Limits

Cable lengths cannot exceed 500 feet at 4800 baud.

### The Network is Terminated Correctly

Each APOGEE FLN network segment must be terminated on both ends to eliminate signal reflections. It is recommended that the Siemens Building Automation BLN Trunk Terminator (PN: 538-664) be used and that the network termination switch on the E7 drive, S1-1, be set to OFF.

### Shield Is Continuous And Both Ends Of The Shield Are Grounded

As each drive is daisy-chained to the next, twist together the shields of the adjoining cables. Do not connect the shield at each drive. The continuous shield should then be single-point grounded at the field panel.

### Cable Is Routed Correctly

Route the cable away from all power and high frequency lines. Routing within a separate conduit is preferred.

# Drive Faults

## ◆ Communications Fault

Table A.6 - Drive Faults			
Fault	Description	Cause	Corrective Action
CE	Communication Error	Connection is broken or master has stopped communicating	Check all connections Verify all APOGEE FLN software configurations

## ◆ E7 Drive Faults

Table A.7 - Description of Fault Numbers	
Fault Number	Description
1	DC Bus Fuse Open (PUF)
2	DC Bus Under Voltage (UV1)
3	Control Power Supply Under Voltage (UV2)
4	MC Answerback (UV3)
5	Short Circuit Fault
6	Ground Fault (GF)
7	Over Current (OC)
8	DC Bus Over Voltage (OV)
9	Overheat Fault (OH)
10	Overheat 1 Fault (OH1)
11	Motor Overload (OL1)
12	Inverter Overload (OL2)
13	Over Torque Detection 1 (OL3)
14	Over Torque Detection 2 (OL4)
15	N/A
16	N/A
17	External Fault 3 (EF3)
18	External Fault 4 (EF4)
19	External Fault 5 (EF5)
20	External Fault 6 (EF6)
21	External Fault 7 (EF7)
22	External Fault 8 (EF8)
23	Drive Fan Fault
24	Over Speed Fault
25	N/A
26	N/A
27	N/A
28	Output Phase Loss (LF)
29	Overheat 3 (OH3)
30	Operator Connection Fault (OPR)
31	Err Fault
32	Overheat 4 Fault (OH4)
33	Modbus Com Error (CE)
34	N/A
35	N/A
36	N/A
37	N/A
38	N/A
39	External Fault 0 (EF0)
40	PID Feedback Loss
41	N/A
42	N/A
43	N/A

# Appendix B Hex/Dec Conversion

---

*This appendix describes the decimal to hexadecimal conversion.*

**Hex/Dec Conversion Table ..... B - 3**

This page intentionally left blank.

# Hex/Dec Conversion Table

Table B.1 – Hex/Dec Conversions

Hex	Dec	Hex	Dec	Hex	Dec	Hex	Dec	Hex	Dec
0	0	34	52	68	104	9C	156	D0	208
1	1	35	53	69	105	9D	157	D1	209
2	2	36	54	6A	106	9E	158	D2	210
3	3	37	55	6B	107	9F	159	D3	211
4	4	38	56	6C	108	A0	160	D4	212
5	5	39	57	6D	109	A1	161	D5	213
6	6	3A	58	6E	110	A2	162	D6	214
7	7	3B	59	6F	111	A3	163	D7	215
8	8	3C	60	70	112	A4	164	D8	216
9	9	3D	61	71	113	A5	165	D9	217
A	10	3E	62	72	114	A6	166	DA	218
B	11	3F	63	73	115	A7	167	DB	219
C	12	40	64	74	116	A8	168	DC	220
D	13	41	65	75	117	A9	169	DD	221
E	14	42	66	76	118	AA	170	DE	222
F	15	43	67	77	119	AB	171	DF	223
10	16	44	68	78	120	AC	172	E0	224
11	17	45	69	79	121	AD	173	E1	225
12	18	46	70	7A	122	AE	174	E2	226
13	19	47	71	7B	123	AF	175	E3	227
14	20	48	72	7C	124	B0	176	E4	228
15	21	49	73	7D	125	B1	177	E5	229
16	22	4A	74	7E	126	B2	178	E6	230
17	23	4B	75	7F	127	B3	179	E7	231
18	24	4C	76	80	128	B4	180	E8	232
19	25	4D	77	81	129	B5	181	E9	233
1A	26	4E	78	82	130	B6	182	EA	234
1B	27	4F	79	83	131	B7	183	EB	235
1C	28	50	80	84	132	B8	184	EC	236
1D	29	51	81	85	133	B9	185	ED	237
1E	30	52	82	86	134	BA	186	EE	238
1F	31	53	83	87	135	BB	187	EF	239
20	32	54	84	88	136	BC	188	F0	240
21	33	55	85	89	137	BD	189	F1	241
22	34	56	86	8A	138	BE	190	F2	242
23	35	57	87	8B	139	BF	191	F3	243
24	36	58	88	8C	140	C0	192	F4	244
25	37	59	89	8D	141	C1	193	F5	245
26	38	5A	90	8E	142	C2	194	F6	246
27	39	5B	91	8F	143	C3	195	F7	247
28	40	5C	92	90	144	C4	196	F8	248
29	41	5D	93	91	145	C5	197	F9	249
2A	42	5E	94	92	146	C6	198	FA	250
2B	43	5F	95	93	147	C7	199	FB	251
2C	44	60	96	94	148	C8	200	FC	252
2D	45	61	97	95	149	C9	201	FD	253
2E	46	62	98	96	150	CA	202	FE	254
2F	47	63	99	97	151	CB	203	FF	255
30	48	64	100	98	152	CC	204	100	256
31	49	65	101	99	153	CD	205		
32	50	66	102	9A	154	CE	206		
33	51	67	103	9B	155	CF	207		





**YASKAWA ELECTRIC AMERICA, INC.**

Drives Division  
16555 W. Ryerson Rd., New Berlin, WI 53151, U.S.A.  
Phone: (800) YASKAWA (800-927-5292) Fax: (262) 782-3418  
Internet: <http://www.drives.com>

**YASKAWA ELECTRIC AMERICA, INC.**

Chicago-Corporate Headquarters  
2121 Norman Drive South, Waukegan, IL 60085, U.S.A.  
Phone: (800) YASKAWA (800-927-5292) Fax: (847) 887-7310  
Internet: <http://www.yaskawa.com>

**MOTOMAN INC.**

805 Liberty Lane, West Carrollton, OH 45449, U.S.A.  
Phone: (937) 847-6200 Fax: (937) 847-6277  
Internet: <http://www.motoman.com>

**YASKAWA ELECTRIC CORPORATION**

New Pier Takeshiba South Tower, 1-16-1, Kaigan, Minatoku, Tokyo, 105-0022, Japan  
Phone: 81-3-5402-4511 Fax: 81-3-5402-4580  
Internet: <http://www.yaskawa.co.jp>

**YASKAWA ELETRICO DO BRASIL COMERCIO LTDA.**

Avenida Fagundes Filho, 620 Bairro Saude Sao Paulo-SP, Brasil CEP: 04304-000  
Phone: 55-11-5071-2552 Fax: 55-11-5581-8795  
Internet: <http://www.yaskawa.com.br>

**YASKAWA ELECTRIC EUROPE GmbH**

Am Kronberger Hang 2, 65824 Schwalbach, Germany  
Phone: 49-6196-569-300 Fax: 49-6196-888-301

**MOTOMAN ROBOTICS AB**

Box 504 S38525, Torsas, Sweden  
Phone: 46-486-48800 Fax: 46-486-41410

**MOTOMAN ROBOTEC GmbH**

Kammerfeldstrabe 1, 85391 Allershausen, Germany  
Phone: 49-8166-900 Fax: 49-8166-9039

**YASKAWA ELECTRIC UK LTD.**

1 Hunt Hill Orchardton Woods Cumbernauld, G68 9LF, Scotland, United Kingdom  
Phone: 44-12-3673-5000 Fax: 44-12-3645-8182

**YASKAWA ELECTRIC KOREA CORPORATION**

Paik Nam Bldg. 901 188-3, 1-Ga Euljiro, Joong-Gu, Seoul, Korea  
Phone: 82-2-776-7844 Fax: 82-2-753-2639

**YASKAWA ELECTRIC (SINGAPORE) PTE. LTD.**

Head Office: 151 Lorong Chuan, #04-01, New Tech Park Singapore 556741, Singapore  
Phone: 65-282-3003 Fax: 65-289-3003

**TAIPEI OFFICE (AND YATEC ENGINEERING CORPORATION)**

10F 146 Sung Chiang Road, Taipei, Taiwan  
Phone: 886-2-2563-0010 Fax: 886-2-2567-4677

**YASKAWA JASON (HK) COMPANY LIMITED**

Rm. 2909-10, Hong Kong Plaza, 186-191 Connaught Road West, Hong Kong  
Phone: 852-2803-2385 Fax: 852-2547-5773

**BEIJING OFFICE**

Room No. 301 Office Building of Beijing International Club,  
21 Jianguomanwai Avenue, Beijing 100020, China  
Phone: 86-10-6532-1850 Fax: 86-10-6532-1851

**SHANGHAI OFFICE**

27 Hui He Road Shanghai 200437 China  
Phone: 86-21-6553-6600 Fax: 86-21-6531-4242

**SHANGHAI YASKAWA-TONJI M & E CO., LTD.**

27 Hui He Road Shanghai 200437 China  
Phone: 86-21-6533-2828 Fax: 86-21-6553-6677

**BEIJING YASKAWA BEIKE AUTOMATION ENGINEERING CO., LTD.**

30 Xue Yuan Road, Haidian, Beijing 100083 China  
Phone: 86-10-6232-9943 Fax: 86-10-6234-5002

**SHOUGANG MOTOMAN ROBOT CO., LTD.**

7, Yongchang-North Street, Beijing Economic & Technological Development Area,  
Beijing 100076 China  
Phone: 86-10-6788-0551 Fax: 86-10-6788-2878

**YEA, TAICHUNG OFFICE IN TAIWAN**

B1, 6F, No.51, Section 2, Kung-Yi Road, Taichung City, Taiwan, R.O.C.  
Phone: 886-4-2320-2227 Fax: 886-4-2320-2239